

Pos.Nr. Pos.no. Position	Beschreibung Description Désignation	Preisgruppe Price bracket Catégorie de prix	
		Art.-Nr. Art.no. Réf.	
1	Schraube 2,2 x 9,5 Screw 2,2 x 9,5	85808	2
2	Führerhaus Criver cab	114543	35
3	Umlaufblech kpl. Gangway ass.	114544	45
4	Teilesatz Part set	108252	18
5	Teilesatz Part set	108255	20
6	Drahtstange Switch rod	114547	4
7	Kessel kpl. Betr. Nr. 18 201 Boiler ass. Betr. No. 18 201	114537	79
8	Teilesatz Part set	114545	13
9	Teilesatz Part set	114546	12
10	Steckteilesatz Push in part set	108271	17
11	Lokpfeife Loco whisgle	108274	6
12	Teilesatz Part set	114555	12
13	Leitungssatz Push in part set	108285	15
14	Teilesatz Part set	108286	14
15	Drahtstangensatz Switch Mod-set	108287	31
16	Sandrohrsatz Sandcase set	114556	12
17	Federbügel Spring clip	108589	3
18	Bolzen Pin	108590	3
19	Kessel kpl. Betr. Nr. Boiler ass. Betr. No.	114557	79
20	Dachfenstergitter Dormer window	109496	5
20	Bürstenfeder Spring	114197	2

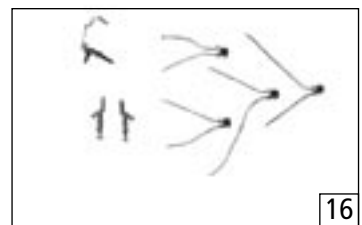

Pos.Nr. Pos.no. Position	Beschreibung Description Désignation	Preisgruppe Price bracket Catégorie de prix	
		Art.-Nr. Art.no. Ref.	
1	Schraube M 2 x 4 Screw M 2 x 4	85670	2
2	Schraube M 2 x 8 Screw M 2 x 8	85674	2
3	FK-Schraube Screw	85756	2
4	Schraube M 2 x 25 Screw M 2 x 25	85759	3
5	Ansatzschraube 1,4 x 3,2 / 1,1 Screw 1,4 x 3,2 / 1,1	85764	2
6	Schraube 2,2 x 6,5 Screw 2,2 x 6,5	85800	2
7	Druckfeder Spring	86271	3
8	Schnecken Zahnrad Gear	86413	4
9	Zahnrad Z=28 Gear Z=28	86517	2
10	Schnecke m=0,5 Worm m=0,5	86702	5
11	Kardanhülse Cardan bearing	87074	4
12	Lokplatine kpl. Printed circuit ass.	87871	51
13	Puffer gewölbt bedruckt Buffer voulded	88629	4
14	Puffer flach bedruckt Buffer flat	88630	4
15	Lager für Schneckenachse Worm axle bearing	89749	6
16	Kardankugel Cardan ball	95797	2
17	Drahtlampe Light bulb	109321	10
18	Atrappenrahmen klein Push in part. set	107808	3
19	Getriebedeckel Gear cover	108238	20
20	Teilesatz Part set	108239	23
21	Kuppelstange links hinten Connecting rod left, rear	108240	9
22	Kuppelstange rechts hinten Connecting rod right, rear	108241	9
23	Kuppelstange links vorne Connecting rod left, front	108242	9
24	Kuppelstange rechts vorne Connecting rod right, front	108243	9
25	Steuerung kpl. Steering ass.	108244	74
26	Schneckensatz kpl. Worm set	108246	24
27	Vorlaufgestell kpl. Pilot frame ass.	108247	34
28	Nachlaufgestell kpl. Tail bogie ass.	108248	28
29	Grundrahmen Frame	114542	30
30	Radsatz-Treibrad 1 Wheelset 1	108267	26
31	Radsatz-Treibrad 2 Wheelset 2	108268	26
32	Radsatz-Treibrad 3 Wheelset 3	108269	28
33	Teilesatz Part set	108272	21
34	Teilesatz Part set	108273	14
35	Zylinderblock Cylinder block	108280	20
36	Vorlaufadsatz Pilot wheelset	108281	14
37	Nachlaufadsatz Teil wheelset	108282	14
38	Schneckendeckel Worm cover	94707	3
39	Scheibe Spacer	86108	2
40	Lautsprechergehäuse Loud speaker body	110879	6
41	Schleifer Collector	40064	-
42	Schraube M 1,6 x 12 Screw M 1,6 x 12	85763	2
43	Lokplatine kpl. Printed circuit ass.	87875	43
44	Radsatz Treibrad 1 Wheelset 1	108306	26
45	Radsatz Treibrad 2 Wheelset 2	108307	26
46	Radsatz Treibrad 3 Wheelset 3	108308	28
47	Vorlaufgestell kpl. Pilot frame ass.	108309	34
48	Nachlaufgestell kpl. Tail bogie ass.	108310	28
49	Schleiferkontakt Collector contact	108311	3
50	Vorlaufadsatz Pilot wheelset	108312	14
51	Nachlaufadsatz Tail wheelset	108313	14

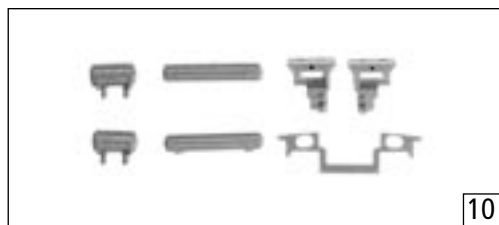
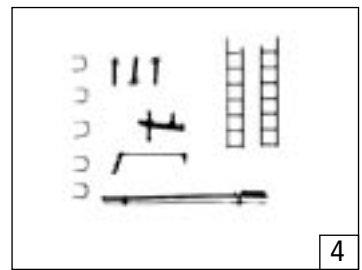
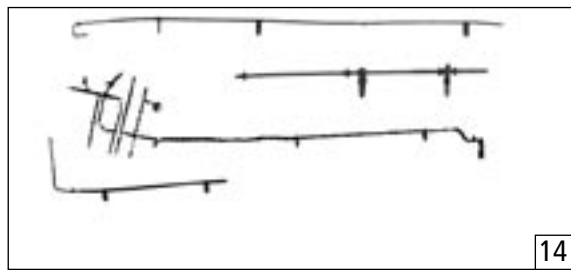
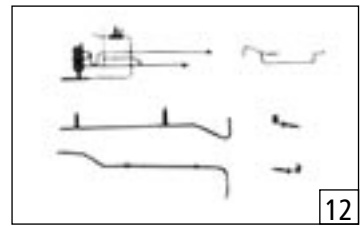
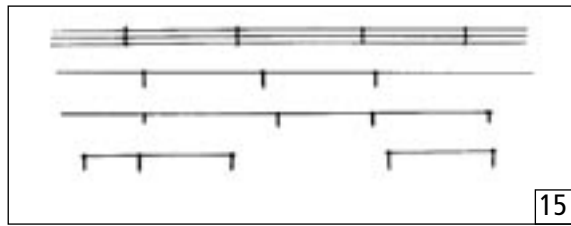
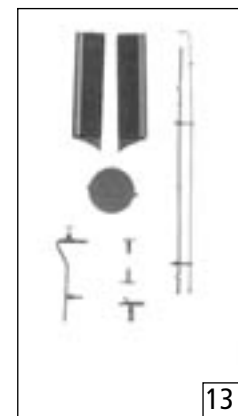
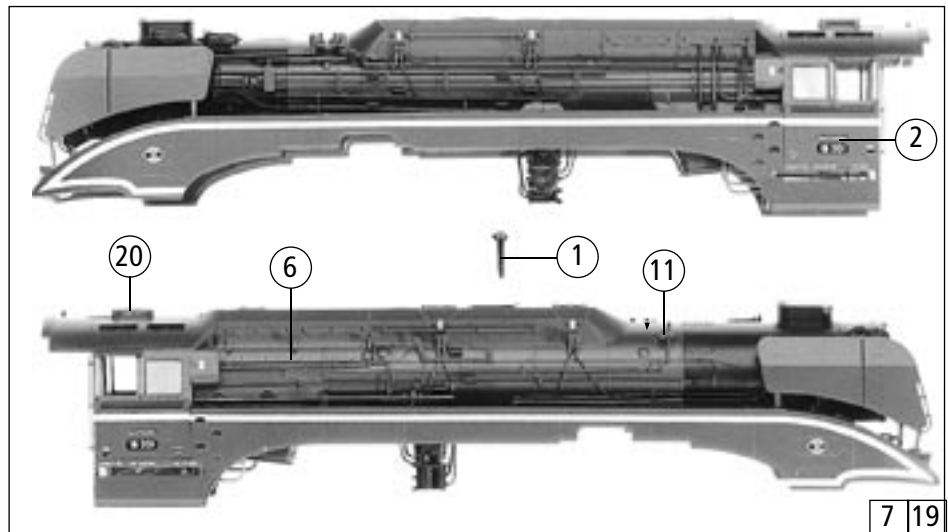
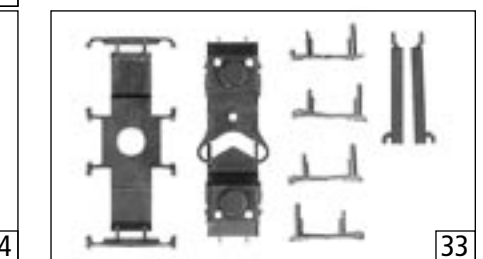
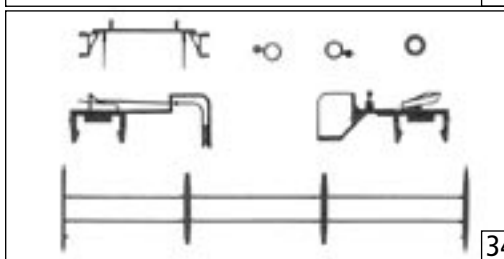
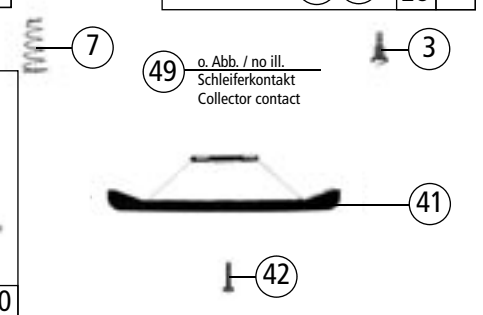
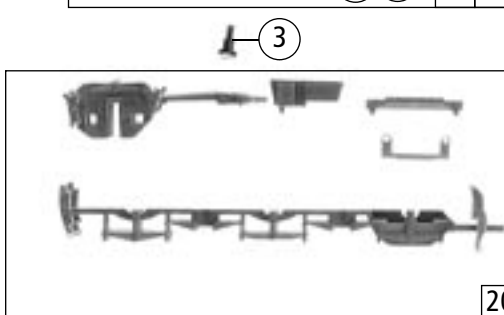
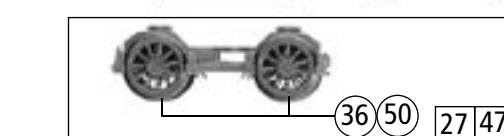
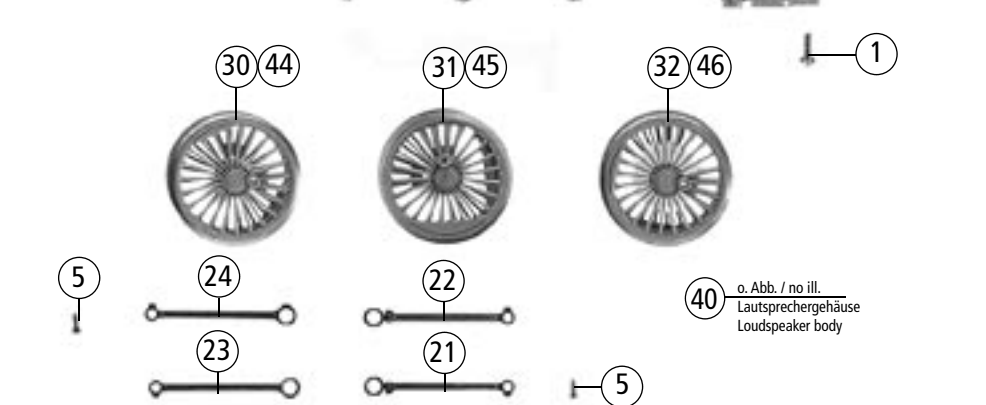
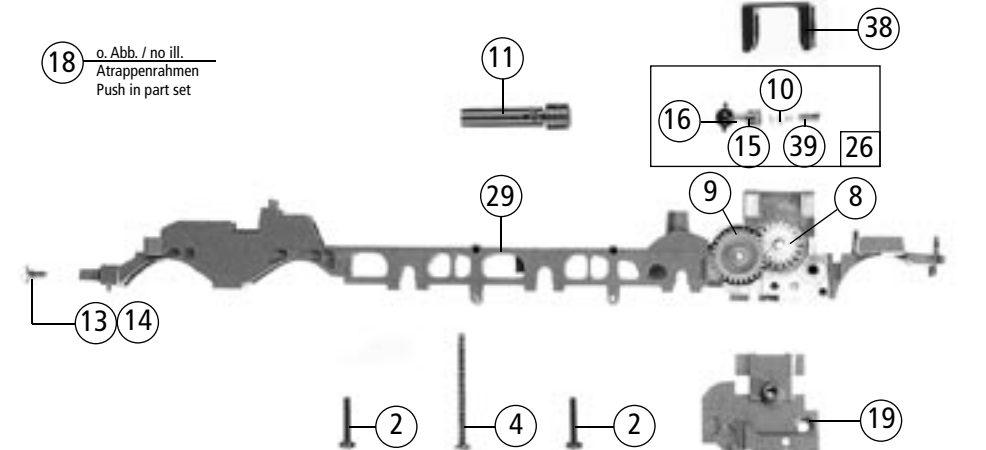
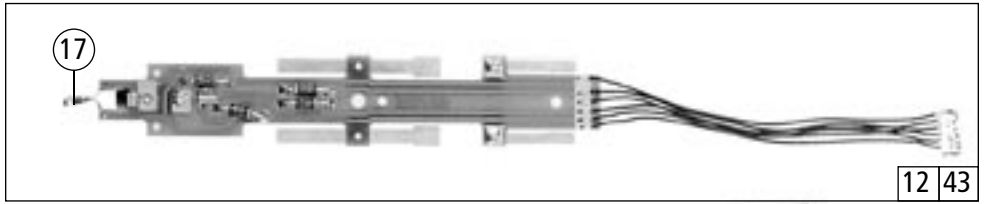
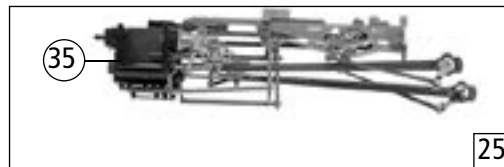

Pos.Nr. Pos.no. Position	Beschreibung Description Désignation	Preisgruppe Price bracket Catégorie de prix	Art.-Nr. Art.no. Réf.
1	Motor Motor	85128	57
2	Tenderplatine kpl. Printed circuite	87870	58
3	Puffer gewölbt bedruckt Buffer voulted	88629	4
4	Puffer flach bedruckt Buffer flat	88630	4
5	Brückenstecker Bridge connector	100644	7
6	Lampenhalter Lamp holder	114853	2
7	Kardanwelle Cardan shaft	106216	4
8	Teilesatz Part set	108249	25
9	Tendergehäuse kpl. Betr. Nr. 18 201 Tender body Betr. No. 18 201	114539	53
10	Steckteilesatz mit Kupplungshalter Partset with coupling holder	108259	20
11	Motorspange Motor clamp	108264	2
12	Drahtstange Hand rail	108275	2
13	Tendergrundrahmen Tender lower part	114550	30
14	Griffstangensatz Handrail set	108288	7
15	Griffstange Handrail	108591	3
16	Universal Kupplung Universal-coupling	89282	5
17	Tenderoberteil Body of tender	114548	34
18	Lichtleiter Tender Light transmission tender	113204	2
19	Heckleizersatz Ladderset, rear	111805	7
20	Teilesatz Parts set	113206	6
21	Teilesatz Parts set	113207	22
22	Griffstange Handrail	113550	2
23	Griffstange kurz Handrail short	114210	3
24	Tendergehäuse kpl. Zusatztender Tender body addition tender	114540	53
25	Getriebeboden Gear bottom	114541	14
26	Fenster f. Zusatztender Window for addition tender	114551	10
27	Steigleiter f. Zusatztender Ladder for addition tender	114552	2
28	Teilesatz f. Zusatztender Parts set for addition tender	114553	7
29	Nummertafel für Zusatztender Numberboard for addition tender	114554	10
30	Tenderleitungssatz Tender push in part set	114666	6
31	Tenderplatine kpl. Printed circuit ass.	87873	50

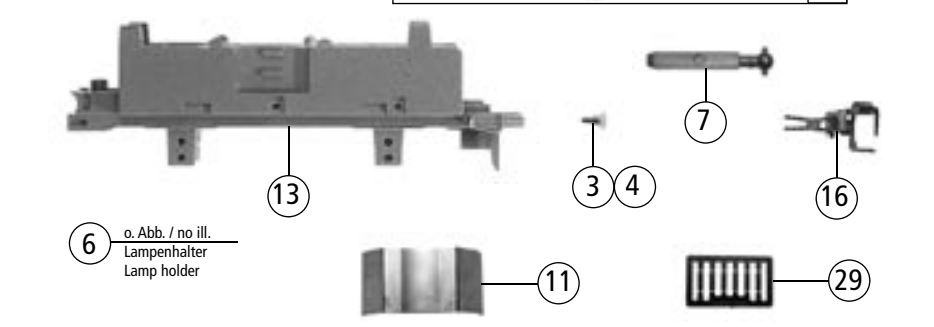
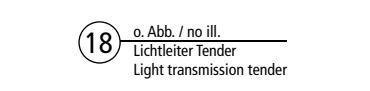
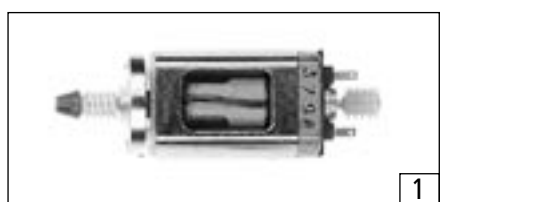
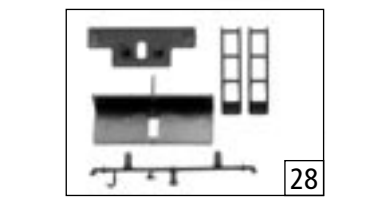
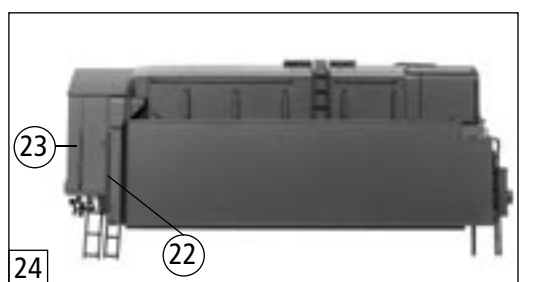
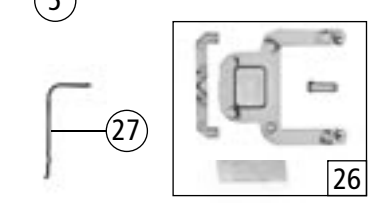
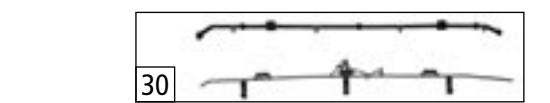
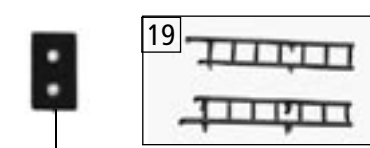
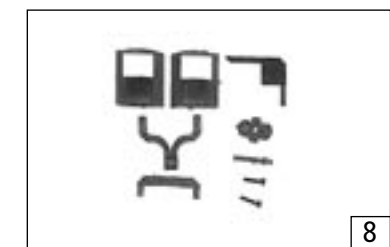
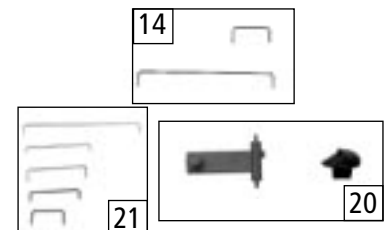
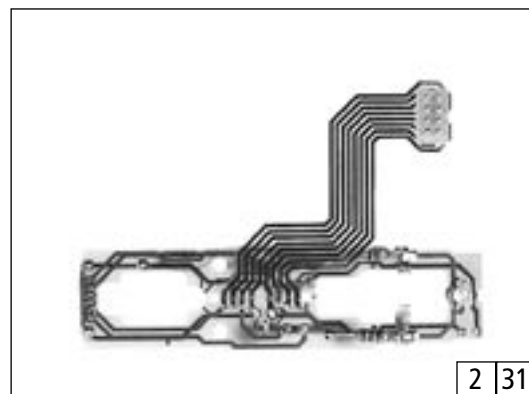
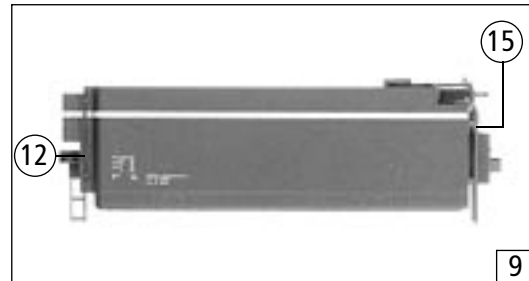

18 o. Abb. / no ill.
Lichtleiter Tender
Light transmission tender

6 o. Abb. / no ill.
Lampenhalter
Lamp holder

Pos.Nr. Pos.no. Position	Beschreibung Description Désignation	Preisgruppe Price bracket Catégorie de prix	
		Art.-Nr. Art.no. Réf.	
1	Hafringsatz Traction tyre set	85622	19
2	Zugfeder Spring	86208	2
3	Schneckenzahnrad Gear	86413	4
4	Zahnrad Z=21 G Gear Z=21 G	86414	4
5	Zahnrad Z=24 Gear Z=24	86516	2
6	Schraube 2 x 10 Screw 2 x 10	85675	2
7	Radsatz Wheelset	90454	16
8	Blende Bogie frame	94574	12
9	Steckteilesatz Part set	108261	15
10	Getriebesatz Gear part set	108262	18
11	Getriebeboden Gear bottom	108263	14
12	Radsatz mit Zahnrad und Hafringe Wheelset with gear and traction tyre	108265	20
13	Nummer tafelsatz Loco number set	114549	20
14	Zurüstbeutel Bag with accessories	108277	28
15	Teilesatz Part set	108322	8
16	Tafelsatz Number set	114538	24
17	Feder Spring	86234	2
18	Tenderunterteil für Zusatztender Tender bottom for addition tender	114663	30
19	Hafringsatz Traction tyre set	85623	16
20	Radsatz Wheelset	108304	18
21	Radsatz mit Hafringen und Zahnrad Wheelset with traction tyre and gear	108305	20

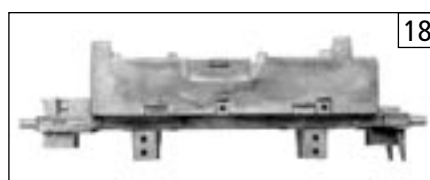
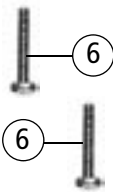
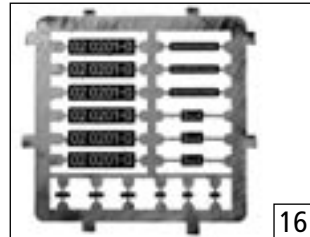
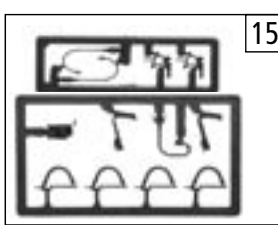
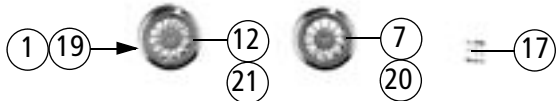
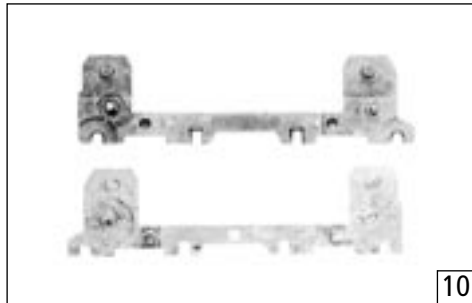

2 o. Abb. / no ill.
Zugfeder
Spring

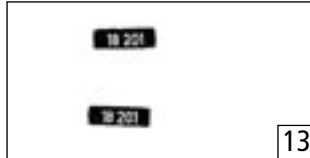
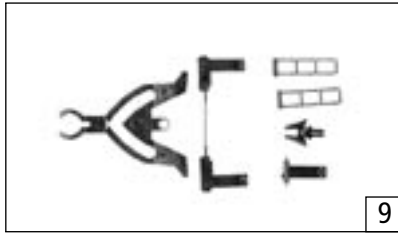

14 o. Abb. / no ill.
Zurüstbeutel
Bag with accessories

Symbolische Darstellung
Symbolic Illustration
Illustration figurative

Ersatzteile erhalten Sie bei Ihrem Fachhändler, Ihrer Landesvertretung, oder bei:
You can order your Replacement Parts at your local dealer, your country representative, or:
Passez commande des pièces détachées chez votre détaillant, chez le S.A.V. de votre importateur national ou en direct au S.A.V. ROCO:

ROCO Modellsenspielwaren VertriebsgmbH & Co. Handels KG
— Service —
Georg-Wrede-Straße 49, D-83395 Freilassing
☎ +49 / (0)86 54 / 47 63 0
Fax: +49 / (0)86 54 / 47 63 50
E-Mail: service@roco-online.de